



ENGLISH

INDEX

1	FACSIMILE COPY OF EU DECLARATION OF CONFORMITY	3
2	GENERAL WARNINGS	3
3	SAFETY INSTRUCTIONS	4
	3.1 SAFETY WARNINGS	4
	3.2 FIRST AID RULES	5
	3.3 GENERAL SAFETY RULES	5
	3.4 PACKAGING	5
	3.5 PACKAGE CONTENTS/PRE-INSPECTION	6
4	BECOMING ACQUAINTED WITH K24	6
	4.1 COMPATIBLE LIQUIDS	6
	4.2 DISPLAY LCD	7
	4.3 DISPLAY POSITIONING (METER VERSION ONLY)	7
	4.4 USERS BUTTONS	8
5	OPERATING MODES	8
6	INSTALLATION	8
	6.1 PULSER INSTALLATION DIAGRAM	8
	6.2 METER INSTALLATION	9
7	DAILY USE	9
	7.1 DISPENSING IN NORMAL MODE	9
	7.1.1 PARTIAL RESET (NORMAL MODE)	10
	7.1.2 RESETTING THE RESET TOTAL	10
	7.2 DISPENSING WITH FLOW RATE MODE DISPLAY	11
	7.2.1 PARTIAL RESET (FLOW RATE MODE)	11
8	CALIBRATION	11
	8.1 DEFINITIONS	11
	8.2 CALIBRATION MODE	12
	8.2.1 DISPLAY OF CURRENT CALIBRATION FACTOR AND RESTORING FACTORY FACTOR.	13
	8.2.2 IN FIELD CALIBRATION	14
	8.2.2.1 IN-FIELD CALIBRATION PROCEDURE	14
	8.2.3 DIRECT MODIFICATION OF K FACTOR	16
9	METER CONFIGURATION	17
10	MAINTENANCE	18
11	MALFUNCTIONS	19
12	DEMOLITION AND DISPOSAL	19
14	EXPLODED VIEWS AND OVERALL DIMENSIONS	21

BULLETIN MO171F

1 FACSIMILE COPY OF EU DECLARATION OF CONFORMITY

The undersigned: PIUSI S.p.A.

Via Pacinotti 16/A z.i. Rangavino - 46029 Suzzara - Mantova - Italy

HEREBY STATES under its own responsibility that the equipment described below:

Description : **METER**

Model: **K24**

Serial number: refer to Lot Number shown on CE plate affixed to product

Year of manufacture: refer to the year of production shown on the CE plate affixed to the product complies with the following legislation:

- Electromagnetic compatibility

The technical file is at the disposal of the competent authority following motivated request at PIUSI S.p.A. or following request sent to the e-mail address: doc_tec@piusi.com.

THE ORIGINAL DECLARATION OF CONFORMITY IS PROVIDED SEPARATELY WITH THE PRODUCT

2 GENERAL WARNINGS

ATTENTION

To ensure operator safety and to protect the dispensing system from potential damage, workers must be fully acquainted with this instruction manual before attempting to operate the dispensing system.

Symbols used in the manual



The following symbols will be used throughout the manual to highlight safety information and precautions of particular importance:



ATTENTION

This symbol indicates safe working practices for operators and/or potentially exposed persons.



WARNING

This symbol indicates that there is risk of damage to the equipment and/or its components.

NOTE

This symbol indicates useful information.

Manual preservation

This manual should be complete and legible throughout. It should remain available to end users and specialist installation and maintenance technicians for consultation at any time.

Reproduction rights

All reproduction rights are reserved by Piusi S.p.A. The text cannot be reprinted without the written permission of Piusi S.p.A.

© Piusi S.p.A.





THIS MANUAL IS THE PROPERTY OF Piusi S.p.A.

ANY REPRODUCTION, EVEN PARTIAL, IS FORBIDDEN.

This manual belongs to Piusi S.p.A., which is the sole proprietor of all rights indicated by applicable laws, including, by way of example, laws on copyrights. All the rights deriving from such laws are reserved to Piusi S.p.A.: the reproduction, including partial, of this manual, its publication, change, transcription and notification to the public, transmission, including using remote communication media, placing at disposal of the public, distribution, marketing in any form, translation and/or processing, loan and any other activity reserved by the law to Piusi S.p.A..

3 SAFETY INSTRUCTIONS

3.1 SAFETY WARNINGS

Mains - preliminary checks before installation		ATTENTION You must avoid any contact between the electrical power supply and the fluid that needs to be FILTERED.
Maintenance control		Before any checks or maintenance work are carried out, disconnect the power source.
For your safety, review the major ATTENTIONs and cautions below before operating your meter		<u>When metering flammable liquids, observe precautions against fire or explosion</u> <u>When handling hazardous liquids, always follow the liquid manufacturer's safety precautions</u> Always dispose of used cleaning solvents in a safe manner according to the solvent manufacturer's instructions. During meter removal, liquid may spill. Follow the liquid manufacturer's safety precautions to clean up minor spills <u>Do not blow compressed air through the meter</u> <u>Do not allow liquids to dry inside the meter</u>
FIRE AND EXPLOSION		Connect the metal parts of the device to earth Stop operation immediately if static sparking occurs or if you feel a shock. Do not use equipment until you identify and correct the problem. <u>Keep a working fire extinguisher in the work area.</u>
EQUIPMENT MISUSE		<u>Do not operate the unit when fatigued or under the influence of drugs or alcohol.</u> <u>Do not leave the work area while equipment is energized or under pressure.</u> Turn off all equipment when equipment is not in use. Do not alter or modify equipment. Alterations or modifications may void agency approvals and create safety hazards. Route hoses and cables away from traffic areas, sharp edges, moving parts, and hot surfaces. <u>Do not kink or over bend hoses or use hoses to pull equipment.</u> <u>Keep children and animals away from work area.</u> <u>Comply with all applicable safety regulations.</u>
Toxic Fluid or Fumes Hazard		Read MSDSs to know the specific hazards of the fluids you are using. Store hazardous fluid in approved containers, and dispose of it according to applicable guidelines. Prolonged contact with the treated product may cause skin irritation: always wear protective gloves during dispensing.



3.2 FIRST AID RULES

NOTE



Please refer to the safety data sheet for the product

SMOKING PROHIBITED



When operating the dispensing system and in particular during refuelling, do not smoke and do not use open flame.

ATTENTION



When metering flammable liquids, observe precautions against fire or explosion

When handling hazardous liquids, always follow the liquid manufacturer's safety precautions.

Do not submerge the meter

3.3 GENERAL SAFETY RULES

Essential protective equipment characteristics

Wear protective equipment that is:
 - Suited to the operations that need to be performed;
 - Resistant to cleaning products.

Personal protective equipment that must be worn



Safety shoes;



Close-fitting clothing;



Protective gloves;



Safety goggles;

Other equipment



Instruction manual

ATTENTION



If handling hazardous liquids, always follow the Liquid Manufacturer's Safety Precautions. Wear protective clothing such as goggles, gloves and respirator as instructed.

When metering flammable liquids, observe precautions against fire or explosion. Do not meter in the presence of any source of ignition including running or hot engines, lighted cigarettes, or gas or electric heaters

3.4 PACKAGING

K24 comes packed in a cardboard box with a label indicating the following data:

- 1 - contents of the package
- 2 - weight of the contents
- 3 - description of the product

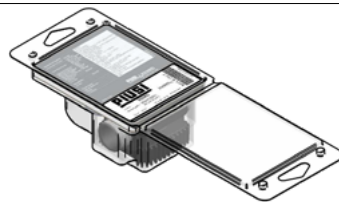

3.5 PACKAGE CONTENTS/PRE-INSPECTION

FOREWORD To open the packaging, use a pair of scissors or a cutter, being careful not to damage the dispensing system or its components.

NOTE  In the event that one or more of the components described below are missing from inside the package, please contact Piusi inc technical support.

WARNING  **Check that the data on the plate correspond to the desired specifications. In the event of any anomaly, contact the supplier immediately, indicating the nature of the defects. Do not use equipment which you suspect might not be safe.**

4 BECOMING ACQUAINTED WITH K24

FOREWORD Electronic digital meter featuring a turbine measurement system, designed for precise measuring of low viscosity fluids.

K24 is available in 2 versions:

1 METER - with LCD display and calibration buttons

2 PULSER - single-channel impulse, connectable with a remote display.

Two big groups are suitable for its use:

A With body made of inconductive plastic material of dark colour , divided into high flow rate versions and low flow rate versions, with stainless steel F/F bushing

B With body made of inconductive plastic material of dark colour with galvanized steel bushing

flow rate High flow rate: 120 l/min

values Low flow rate: 60 l/min

4.1 COMPATIBLE LIQUIDS

Turbine measurement system The turbine is placed inside a hole through the body of k24, fitted with M-M threaded inlet and outlet. The supplied F-F bushing enables several combinations of threads. K24 HAS 2 RUBBER PROTECTIONS, DESIGNED TO ACT AS GASKETS TOO.
The liquids compatible with k24 are at low viscosity, namely:

body made of • Water

inconductive plastic • Aus32/Aus40 (D.E.F., Ad-Blue)

material of light colour • Milk not suitable for human consumption

- Windscreen
- Antifreeze

body made of • Diesel fuel

inconductive plastic • Windscreen

material of dark colour • Antifreeze

- Paraffinic HVO/XTL: EN 15940

Main components: K24 Meter

1	LCD display	3	CAL key
2	RESET key	4	F-F bushing

Main components: K24 Pulser

1	Plate with technical data
2	F-F bushing



4.2 DISPLAY LCD

FOREWORD The "LCD" of the METER features two numerical registers and various indications displayed to the user only when the applicable function so requires.

1	Partial register (5 figures with moving comma FROM 0.1 to 99999) indicating the volume dispensed since the reset button was last pressed	6	Indication of type of total, (TOTAL / Reset TOTAL);
2	Indication of battery charge	7	Indication of unit of measurement of Totals: L=Litres Gal=Gallons
3	Indication of calibration mode	8	Indication of Flow Rate mode
4	Totals register (6 figures with moving comma FROM 0.1 to 999999), that can indicate two types of Total: 4.1. General Total that cannot be reset (TOTAL) 4.2. Resettable total (Reset TOTAL)	9	Indication of unit of measurement of Partial: Qts=Quarts Pts=Pints L=Litres Gal=Gallons
5	Indication of total multiplication factor (x10 / x100)		

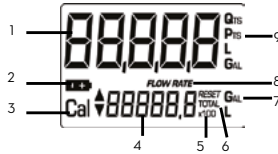

4.3 DISPLAY POSITIONING (METER VERSION ONLY)

FOREWORD The square shape of the k24 body allows the card to be rotated in its housing, thus ensuring great versatility in positioning

This allows easy display readings in any position. The card housing is closed by a plastic cover sealed through a rubber protection acting as a gasket as well. This can be easily removed unscrewing the 4 screws that fix both the cover and the card (†).

ATTENTION  **While fixing the K24 card, make sure the battery contact cable is not placed above the circular housing of the bulb.**



4.4 USERS BUTTONS

FOREWORD

The METER features two buttons (RESET and CAL) which individually perform two main functions and, together, other secondary functions.

MAIN FUNCTIONS

- for the RESET key, resetting the partial register and Reset Total

PERFORMED

- for the CAL key, entering instrument calibration mode

SECONDARY

Used together, the two keys permit entering configuration mode where the desired unit of measurement can be set.

FUNCTIONS

LEGEND

Calibrate means performing actions on the meter keys. Below is the legend of the symbols used to describe the actions to be performed

SHORT PRESSURE OF CAL KEY



LONG PRESSURE OF cal KEY



short pressure of reset key



long pressure of reset key



5 OPERATING MODES

OPERATING MODES

The user can choose between two different operating modes:

The meter features a non-volatile memory for storing the dispensing data, even in the event of a complete power break for long periods.

The measurement electronics and the LCD display are fitted in the top part of the K24 which remains isolated from the fluid-bath measurement chamber and sealed from the outside by means of a cover.

1 - Normal Mode

Normal Mode: Mode with display of Partial and Total dispensed quantities

2 - Flow rate Mode

Flow Rate Mode: Mode with display of Flow Rate, as well as Partial dispensed quantity.

6 INSTALLATION

6.1 PULSER INSTALLATION DIAGRAM

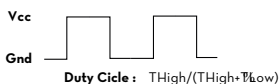
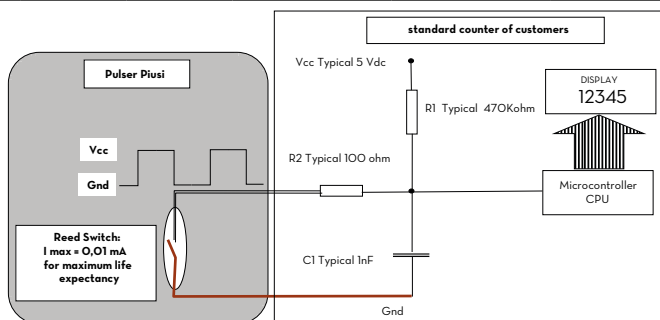

MODEL	Flow Rate Field		Pulsar		Frequency Signal Max	Square Wave Duty Cycle
	L/min	G/min	Pulse/Liter (Approximately)	Pulse/Gal (Approximately)		
K24	5-120	1,3 - 31,7	100	379	200 Hz	70-90%

To increase the life expectancy of the flow meters, it is recommended to keep the current value as low as possible (approx. 0.1 mA)

6.2 METER INSTALLATION

FOREWORD K24 features a threaded, perpendicular inlet and outlet (1" BSP male and female that can be combined together). It has been designed to be easily installed in any position: fixed in-line or mobile on a dispensing nozzle. In order to improve the life of the turbine, it is recommended to fit a strainer before the meter itself

ATTENTION  **An F/F coupling, complete with its gasket, is supplied for installations on male couplings. Always screw the side with gasket on K24.**

It is up to the installer to use another gasket on the other side of the coupling.

The gasket used has the following characteristics: flat seal id=24, od=35.5,thick = 2

Material: NBR 70 SH

For installations on system, position K24 so that the battery housing can be easily reached.

NE

7 DAILY USE

FOREWORD The only operations that need to be done for daily use are partial and/or resettable total register resetting. The user should use only the dispensing system of k24. Occasionally the meter may need to be configured or calibrated. To do so, please refer to the relevant chapters.

Below are the two typical normal operation displays. One display page shows the partial and reset total registers. The other shows the partial and general total. Switchover from resettable total to general total display is automatic and tied to phases and times that are in factory set and cannot be changed.



NOTE



6 digits are available for Totals, plus two icons x 10 / x100. The increment sequence is the following:

0.0 -> 99999.9 -> 999999 -> 100000 x 10 -> 999999 x 10 -> 100000 x 100 -> 999999 x 100

7.1 DISPENSING IN NORMAL MODE

FOREWORD Normal mode is the standard dispensing. While the count is made, the partial and resettable total are displayed at the same time (reset total).

WARNING  **Should one of the keys be accidentally pressed during dispensing, this will have no effect.**

STAND BY A few seconds after dispensing has ended, on the lower register, the display switches from resettable total to general total: the word reset above the word total disappears, and the reset total is replaced by the general total.

This situation is called standby and remains stable until the user operates the k24 again.

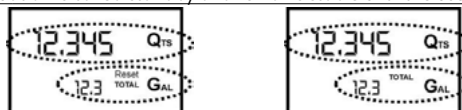

7.1.1 PARTIAL RESET (NORMAL MODE)

The partial register can be reset by pressing the reset key when the meter is in standby, meaning when the display screen shows the word "TOTAL".



After pressing the reset key, during reset, the display screen first of all shows all the lit-up digits and then all the digits that are not lit up.

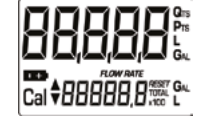

At the end of the process, a display page is first of all shown with the reset partial and the reset total



and, after a few moments, the reset total is replaced by the non resettable Total.



7.1.2 RESETTING THE RESET TOTAL

The reset total resetting operation can only be performed after resetting the partial register. The reset total can in fact be reset by pressing the reset key at length while the display screen shows reset total as on the following display page:

Schematically, the steps to be taken are:

- 1 Wait for the display to show normal standby display page (with total only displayed)
- 2 Press the reset key quickly
- 3 The meter starts to reset the partial
- 4 While the display page showing the reset total is displayed

Press the reset key again for at least 1 second



- 5 The display screen again shows all the segments of the display followed by all the switched-off segments and finally shows the display page where the reset Reset Total is shown.

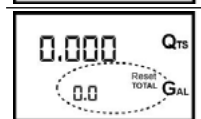

7.2 DISPENSING WITH FLOW RATE MODE DISPLAY

It is possible to dispense fluids, displaying at the same time::

- 1 the dispensed partial
- 2 the Flow Rate in [Partial Unit / minute] as shown on the following display page:
Procedure for entering this mode:



- 1 wait for the Remote Display to go to Standby, meaning the display screen shows Total only
- 2 quickly press the CAL key.
- 3 Start dispensing

The flow rate is updated every 0.7 seconds. Consequently, the display could be relatively unstable at lower flow rates. The higher the flow rate, the more stable the displayed value.

IMPORTANT



The flow rate is measured with reference to the unit of measurement of the Partial. For this reason, in case of the unit of measurement of the Partial and Total being different, as in the example shown below, it should be remembered that the indicated flow rate relates to the unit of measurement of the partial. In the example shown, the flow rate is expressed in Qts/min.

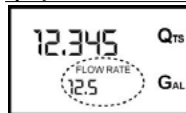

The word "Gal" remaining alongside the flow rate refers to the register of the Totals (Reset or NON Reset) which are again displayed when exiting from the flow rate reading mode.

To return to "Normal" mode, press the CAL key again. If one of the two keys RESET or CAL is accidentally pressed during the count, this will have no effect.

IMPORTANT



Even though in this mode they are not displayed, both the Reset Total and the General Total (Total) increase. Their value can be checked after dispensing has terminated, returning to "Normal" mode, by quickly pressing CAL.

7.2.1 PARTIAL RESET (FLOW RATE MODE)

To reset the Partial Register, finish dispensing and wait for the Remote Display to show a Flow Rate of 0.0 as indicated in the illustration

then quickly press RESET



8 CALIBRATION

When operating close to extreme use or flow rate conditions (close to minimum or maximum acceptable values), an on-the-spot calibration may be required to suit the real conditions in which the K24 is required to operate.

8.1 DEFINITIONS

CALIBRATION FACTOR OR "K FACTOR" Multiplication factor applied by the system to the electrical pulses received, to transform these into measured fluid units.

FACTORY K FACTOR

Factory-set default factor. It is equal to 1,000. This calibration factor ensures utmost precision in the following operating conditions:

Fluid water/urea solution

Temperature: 20°C

Flow rate: 10 - 30 ltr/min

Even after any changes have been made by the user, the factory k factor can be restored by means of a simple procedure.

USER K FACTOR:

Customized calibration factor, meaning modified by calibration.

8.2 CALIBRATION MODE

- Why calibrate?**
- 1 Display the currently used calibration factor:
 - 2 Return to factory calibration (Factory K Factor) after a previous calibration by the user
 - 3 Change the calibration factor using one of the two previously indicated procedures

FOREWORD

Two procedures are available for changing the Calibration Factor:

1 In-Field Calibration, performed by means of a dispensing operation

2 Direct Calibration, performed by directly changing the calibration factor

In calibration mode, the partial and total dispensed quantities indicated on the display screen take on different meanings according to the calibration procedure phase. In calibration mode, the K24 cannot be used for normal dispensing operations. In "Calibration" mode, the totals are not increased

ATTENTION



The K24 features a non-volatile memory that keeps the data concerning calibration and total dispensed quantity stored for an indefinite time, even in the case of a long power break; after changing the batteries, calibration need not be repeated.

8.2.1 DISPLAY OF CURRENT CALIBRATION FACTOR AND RESTORING FACTORY FACTOR.



By pressing the CAL key while the appliance is in Standby, the display page appears showing the current calibration factor used. If no calibration has ever been performed, or the factory setting has been restored after previous calibrations, the following display page will appear:



The word "Fact" abbreviation for "factory" shows that the factory calibration factor is being used

If, on the other hand, calibrations have been made by the user, the display page will appear showing the currently used calibration factor (in our example 0,998).



The word "user" indicates a calibration factor set by the user is being used..



The flow chart alongside shows the switchover logic from one display page to another

In this condition, the Reset key permits switching from User factor to Factory factor.

To confirm the choice of calibration factor, quickly press CAL while "User" or "Fact" are displayed.

After the restart cycle, the K24 uses the calibration factor that has just been confirmed

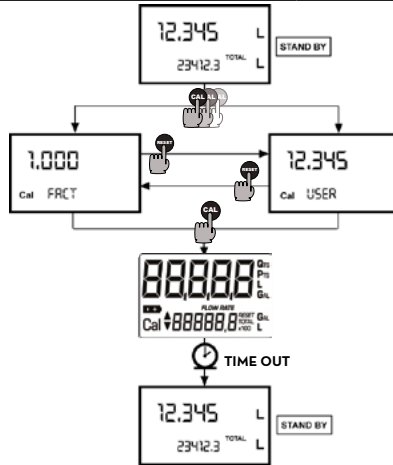

ATTENTION



When the Factory Factor is confirmed, the old User factor is deleted from the memory









8.2.2 IN FIELD CALIBRATION

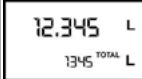





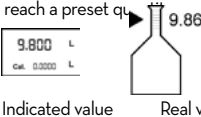
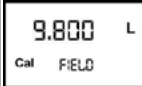

FOREWORD This procedure calls for the fluid to be dispensed into a graduated sample container in real operating conditions (flow rate, viscosity, etc.) requiring maximum precision.

ATTENTION  **For correct K24 calibration, it is most important to:**

- 1 **When the Factory Factor is confirmed, the old User factor is deleted from the memory**
- 2 **use a precise Sample Container with a capacity of not less than 5 litres, featuring an accurate graduated indicator.**
- 3 **ensure calibration dispensing is done at a constant flow rate equivalent to that of normal use, until the container is full;**
- 4 **Not reduce the flow rate to reach the graduated area of the container during the final dispensing stage (the correct method during the final stages of sample container filling consists in making short top-ups at normal operation flow rate) ;**
- 5 **after dispensing, wait a few minutes to make sure any air bubbles are eliminated from the sample container; only read the Real value at the end of this stage, during which the level in the container could drop.**
- 6 **Carefully follow the procedure indicated below.**

8.2.2.1 IN-FIELD CALIBRATION PROCEDURE

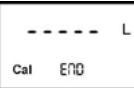
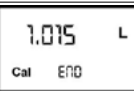
ACTION		DISPLAY
1	NONE Meter in Standby	
2	 LONG CAL key keying The Meter enters calibration mode, shows <<CAL>> and displays the calibration factor in use instead of partial. The words "Fact" and "USER" indicate which of the two factors (factory or user) is currently in use. Important: This factor is that which the instrument also uses for field calibration measurement operations	
3	 LONG RESET key keying The Meter shows "CAL" and the partial at zero. The Meter is ready to perform in-field calibration.	
4	DISPENSING INTO SAMPLE CONTAINER Without pressing any key, start dispensing into the sample contain  Dispensing can be interrupted and started again at will. Continue dispensing until the level of the fluid in the sample container has reached the graduated area. There is no need to reach a preset quantity. 	
5	 SHORT RESET key keying The Meter is informed that the calibration dispensing operation is finished. Make sure dispensing is correctly finished before performing this operation. To calibrate the Meter, the value indicated by the partial totaliser (example 9.800) must be forced to the real value marked on the graduated sample container. In the bottom left part of the display an arrow appears (upwards and downwards), that shows the direction (increase or decrease) of the value change displayed when the following operations 6 or 7 are performed.	

 <p>6</p>	<p>SHORT RESET key keying The arrow changes direction. The operation can be repeated to alternate the direction of the arrow.</p>	
 <p>7</p>	<p>SHORT/LONG CAL key keying The indicated value changes in the direction indicated by the arrow - one unit for every short CAL key keying - continually if the CAL key is kept pressed. The speed increase rises by keeping the key pressed. If the desired value is exceeded, repeat the operations from point (6).</p>	
 <p>8</p>	<p>LONG RESET key keying The Meter is informed that the calibration procedure is finished. Before performing this operation, make sure the INDICATED value is the same as the REAL value.</p> <div style="display: flex; justify-content: space-around; align-items: center;"> <div style="text-align: center;">  <p>Indicated value</p> </div> <div style="text-align: center;">  <p>Real value</p> </div> </div> <p>The Meter calculates the new USER K FACTOR ; this calculation could require a few seconds, depending on the correction to be made ATTENTION: If this operation is performed after action (5), without changing the indicated value, the USER K FACTOR would be the same as the FACTORY K FACTOR, thus it is ignored.</p>	
<p>9</p>	<p>NO OPERATION At the end of the calculation, the new USER K FACTOR is shown for a few seconds, after which the restart cycle is repeated to finally achieve standby condition. IMPORTANT: From now on, the indicated factor will become the calibration factor used by the Meter and will continue to remain such even after a battery change</p>	
<p>10</p>	<p>NO OPERATION The Meter stores the new work calibration factor and is ready to begin dispensing, using the USER K FACTOR that has just been calculated.</p>	

8.2.3 DIRECT MODIFICATION OF K FACTOR

If normal Meter operation shows a mean percentage error, this can be corrected by applying to the currently used calibration factor a correction of the same percentage. In this case, the percentage correction of the USER K FACTOR must be calculated by the operator in the following way

$$\text{New Cal. Factor} = \text{Old Cal. Factor} * (100 - E\% / 100)$$













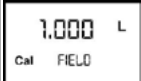

EXAMPLE:

Error percentage found: E% - 0.9 %

CURRENT calibration factor: 1.000

New USER K FACTOR: $1.000 * [(100 - (-0.9))/100] = 1.000 * [(100 + 0.9)/100] = 1.009$

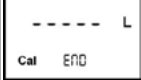
If the Meter indicates less than the real dispensed value (negative error) the new calibration factor must be higher than the old one as shown in the example. The opposite applies if the Meter shows more than the real dispensed value (positive error).

ACTION		DISPLAY
1	NONE METER in Standby.	
2	 LONG CAL KEY KEYING Meter enters calibration mode, shows "CAL" and displays the calibration factor being used instead of the partial. The words "Fact" and "User" indicate which of the two factors (factory or user) is currently being used.	
3	 LONG RESET KEY KEYING The Meter shows "CAL" and the zero partial total. Meter is ready to perform in-field calibration by dispensing - see previous paragraph.	
4	 LONG RESET KEY KEYING We now go on to Direct change of the calibration factor: the word "Direct" appears together with the Currently Used calibration factor. In the bottom left part of the display, an arrow appears (upwards or downwards) defining the direction (increase or decrease) of change of the displayed value when subsequent operations 5 or 6 are performed.	
5	 SHORT RESET KEY KEYING Changes the direction of the arrow. The operation can be repeated to alternate the direction of the arrow.	
6	 SHORT/LONG CAL KEY KEYING The indicated value changes in the direction indicated by the arrow - one unit for every short CAL key keying - continually if the CAL key is kept pressed. The speed increase rises by keeping the key pressed. If the desired value is exceeded, repeat the operations from point (5).	
7	 LONG RESET KEY KEYING The Meter is informed that the calibration procedure is finished. <u>Before performing this operation, make sure the INDICATED value is that required.</u>	
8	NO OPERATION At the end of the calculation, the new USER K FACTOR is shown for a few seconds, after which the restart cycle is repeated to finally achieve standby condition. IMPORTANT: From now on, the indicated factor will become the calibration factor used by the Meter and will continue to remain such even after a battery change	
9	NO OPERATION The Meter stores the new work calibration factor and is ready to begin dispensing, using the USER K FACTOR that has just been changed.	

9 METER CONFIGURATION

The METER feature a menu with which the user can select the main measurement unit, Quarts (Qts), Pints (Pts), Litres (Lit), Gallons (Gal); The combination of the unit of measurement of the Partial register and that of the Totals is predefined according to the following table:

Combination no.	Unit of Measurement Partial Register	Unit of Measurement Totals Register
1	Litres (L)	Litres (L)
2	Gallons (Gal)	Gallons (Gal)
3	Quarts (Qts)	Gallons (Gal)
4	Pints (Pts)	Gallons (Gal)

23

To choose between the 4 available combinations:

1

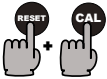

Wait for the METER to go to Standby

2

Then press the CAL and RESET keys together. Keep these pressed until the word "UNIT" appears on the screen together with the unit of measurement set at that time (in this example Litres / Litres)

3

Every short press of the RESET key, the various combinations of the units of measurements are scrolled as shown below:

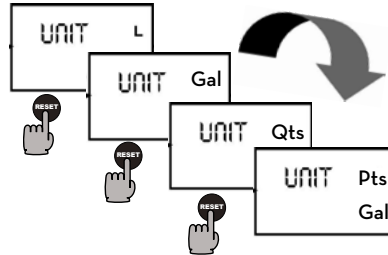

4



ATTENTION

By pressing the CAL key at length, the new settings will be stored, the METER will pass through the start cycle and will then be ready to dispense in the set units.



The Reset Total and Total registers will be automatically changed to the new unit of measurement.
NO new calibration is required after changing the Unit of Measurement.

10 MAINTENANCE

BATTERY REPLACEMENT WARNING

Use 2x1.5 V alkaline batteries size AAA



K24 should be installed in a position allowing the batteries to be replaced without removing it from the system.

K24 features two low-battery alarm levels:

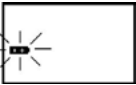
- | | | |
|---|---|--|
| 1 |  | When the battery charge falls below the first level on the LCD, the fixed battery symbol appears. In this condition, K24 continues to operate correctly, but the fixed icon warns the user that it is ADVISABLE to change the batteries. |
| 2 |  | If K24 operation continues without changing the batteries, the second battery alarm level will be reached which will prevent operation. In this condition the battery icon starts to flash and is the only one to remain visible on the LCD. |

- | | | |
|--|---|---|
| o change the batteries, with reference to the exploded diagram positions, proceed as follows | 1 | Press RESET to update all the totals |
| | 2 | Loosen the 4 fixing screws of the lower cover |
| | 3 | Remove the old batteries |
| | 4 | Place the new batteries in the same position as the old ones |
| | 5 | close the cover again, by positioning the rubber protection as a gasket |
| | 6 | K24 will switch on automatically and normal operation can be resumed |

The K24 will display the same Reset Total, the same Total and the same Partial indicated before the batteries were changed.

After changing the batteries, the meter does not need calibrating again.

CLEANING

Only one operation is necessary to clean the k24. After removing k24 from the plant where it was built in, any residual elements can be removed by washing or mechanically-handling. If this operation does not restore a smooth rotation of the turbine, it will have to be replaced.

ATTENTION



Do not discard the old batteries in the environment. Refer to local disposal regulations.
Do not use compressed air onto the turbine in order to avoid its damage because of an excessive rotation

K24 FRONT FACE REPLACEMENT

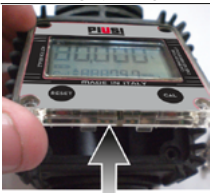

1 - Carefully remove the screws from the corners of the front panel, and then carefully lift the front cover up away from the main body of the meter.

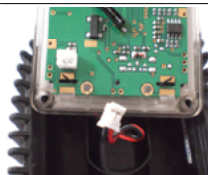

2 - Carefully remove the screws from the corners of the front panel, and then carefully lift the front cover up away from the main body of the meter.

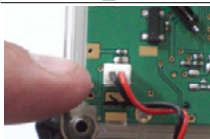

3 - When the new panel is fitted make sure the power adapter is fitted correctly with the location pin in the correct way

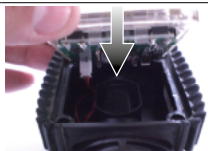

4 - Carefully refit the display panel back onto the main body making sure the wire is tucked into the corner and replace the screws

11 MALFUNCTIONS

Problem	Possible cause	Remedial Action
LCD: no indication	Bad battery contact	Check battery contacts
Not enough measurement precision	Wrong K FACTOR	With reference to paragraph H, check the K FACTOR
	The meter works below minimum acceptable flow rate.	Increase the flow rate until an acceptable flow rate range has been achieved
Reduced or zero flow rate	TURBINE blocked	Clean the TURBINE
The meter does not count, but the flow rate is correct	Incorrect installation of gears after cleaning	Repeat the reassembly procedure
	Possible electronic card problems	Contact your dealer

12 DEMOLITION AND DISPOSAL

Foreword

If the system needs to be disposed, the parts which make it up must be delivered to companies that specialize in the recycling and disposal of industrial waste and, in particular:

Disposing of packing materials

The packaging consists of biodegradable cardboard which can be delivered to companies for normal recycling of cellulose.

Metal Parts

Metal parts, whether paint-finished or in stainless steel, can be consigned to scrap metal collectors.

Disposal of electric and electronic components

These must be disposed of by companies that specialize in the disposal of electronic components, in accordance with the indications of directive 2012/19/EU (see text of directive below).



Information regarding the environment for clients residing within the European Union

European Directive 2012/19/EU requires that all equipment marked with this symbol on the product and/or packaging not be disposed of together with non-differentiated urban waste. The symbol indicates that this product must not be disposed of together with normal household waste. It is the responsibility of the owner to dispose of these products as well as other electric or electronic equipment by means of the specific refuse collection structures indicated by the government or the local governing authorities.

Disposing of RAEE equipment as household wastes is strictly forbidden. Such wastes must be disposed of separately.

Any hazardous substances in the electrical and electronic appliances and/or the misuse of such appliances can have potentially serious consequences for the environment and human health.

In case of the unlawful disposal of said wastes, fines will be applicable as defined by the laws in force.

Miscellaneous parts disposal

Other components, such as pipes, rubber gaskets, plastic parts and wires, must be disposed of by companies specialising in the disposal of industrial waste.

13 TECHNICAL DATA

Measurement system	TURBINE
Resolution	Hi Flow 0.010 lit/pulse
(nominal)	Low Flow 0.005 lit/pulse
Flow Rate	5 · 120 (Litres/minute)
(Range)	FOR DIESEL FUEL, WATER, K24 COL. BEIGE 5 · 100 (Litres/minute) FOR WATER/UREA SOLUTION.
Operating pressure (Max)	10 (Bar) 145 (psi)
Bursting pressure (Min)	40 (Bar)
Storage temperature (Range)	-20 · + 70 (°C)
Storage humidity (Max)	95 (% RH)
Operating temperature (Range)	-10 · + 50 (°C)
Flow resistance	0.30 Bar at 100 lit/min.
Permissible Viscosity (Range)	2 · 5.35 cSt
Accuracy (10-90 litres/min)	+/- 1% after calibration within
Reproducibility (Typical)	+/- 0.3 (%)
Screen	Liquid crystals LCD. Featuring: - 5-figure partial - 6-figure Reset Total plus x10 / x100 - 6-figure non reset Total plus x10 / x100
Power Supply	2x1.5 V alkaline batteries size AAA
Battery life	18 · 36 months
Weight	0.4 Kg (included batteries)
Protection	IP65
BULB (pulser)	Max current: 1 mA Max Voltage: 3 V MaxLoad: 0.003 Watt

14 EXPLODED VIEWS AND OVERALL DIMENSIONS

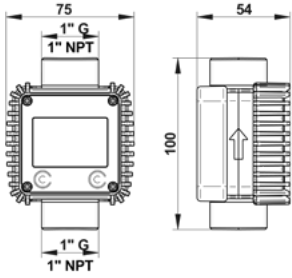
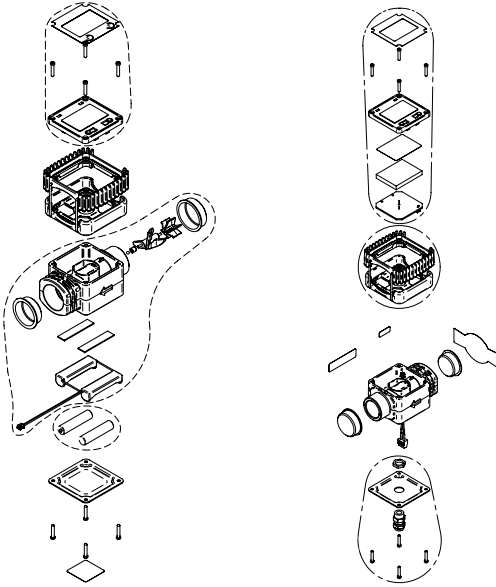

METER

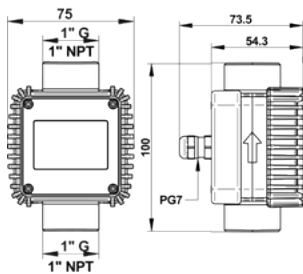
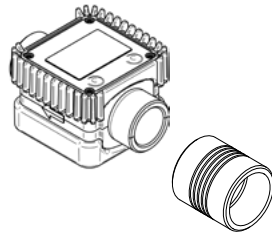

PULSER

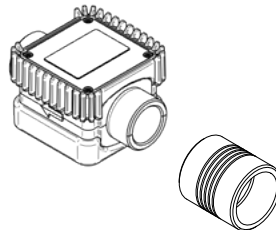





- IT Scarica il manuale nella tua lingua!
- EN Download the manual in your language!
- CS Stáhnout příručku ve vašem jazyce!
- DA Download manualen på dit sprog!
- DE Laden Sie das Handbuch in Ihrer Sprache herunter!
- ES ¡Descarga el manual en tu idioma!
- FI Lataa käsikirja omalla kielelläsi!
- FR Téléchargez le manuel dans votre langue!
- NL Download de handleiding in uw taal!
- PL Pobierz instrukcję w swoim języku!
- PT Baixe o manual em seu idioma!
- RU Загрузите руководство на вашем языке!



[https://www.piusi.com/
support/search-manuals](https://www.piusi.com/support/search-manuals)

americanlube.com